

SKKD 81, SKKE 81

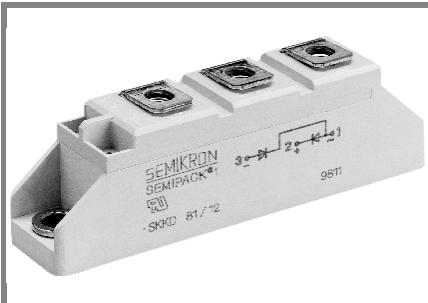

SEMIPACK[®] 1

V_{RSM} V	V_{RRM} V	$I_{FRMS} = 140$ A (maximum value for continuous operation) $I_{FAV} = 80$ A (sin. 180; $T_c = 87$ °C)	
500	400	SKKE 81/04	SKKD 81/04
700	600	SKKE 81/06	SKKD 81/06
900	800	SKKE 81/08	SKKD 81/08
1300	1200	SKKE 81/12	SKKD 81/12
1500	1400	SKKE 81/14	SKKD 81/14
1700	1600	SKKE 81/16	SKKD 81/16
1900	1800	SKKE 81/18	SKKD 81/18
2100	2000	SKKE 81/20H4	SKKD 81/20H4
2300	2200	SKKE 81/22H4	SKKD 81/22H4

Rectifier Diode Modules

SKKD 81

SKKE 81

Features

- Heat transfer through aluminium oxide ceramic isolated metal baseplate
- Hard soldered joints for high reliability
- UL recognized, file no. E 63 532

Typical Applications

- Non-controllable rectifiers for AC/AC converters
- Line rectifiers for transistorized AC motor controllers
- Field supply for DC motors
- Free-wheeling diodes

1) SKKD types only

Symbol	Conditions	Values	Units
I_{FAV}	sin. 180; $T_c = 85$ (100) °C	82 (57)	A
I_D	P3/120; $T_a = 45$ °C; B2 / B6	63 / 70	A
	P3/180F; $T_a = 35$ °C; B2 / B6	135 / 175	A
I_{FSM}	$T_{vj} = 25$ °C; 10 ms	2000	A
	$T_{vj} = 125$ °C; 10 ms	1750	A
i^2t	$T_{vj} = 25$ °C; 8,3 ... 10 ms	20000	A ² s
	$T_{vj} = 125$ °C; 8,3 ... 10 ms	15000	A ² s
V_F	$T_{vj} = 25$ °C; $I_F = 300$ A	max. 1,55	V
$V_{(TO)}$	$T_{vj} = 125$ °C	0,85	V
r_T	$T_{vj} = 125$ °C	1,8	mΩ
I_{RD}	$T_{vj} = 125$ °C; $V_{RD} = V_{RRM}$	max. 4,5	mA
$R_{th(j-c)}$	per diode / per module ¹⁾	0,4 / 0,2	K/W
$R_{th(c-s)}$	per diode / per module ¹⁾	0,2 / 0,1	K/W
T_{vj}		- 40 ... + 125	°C
T_{stg}		- 40 ... + 125	°C
V_{isol}	a. c. 50 Hz; r.m.s.; 1 s / 1 min.	3600 / 3000	V~
V_{isol}	a. c. 50 Hz; r.m.s.; 1 s / 1 min. for SKK...H4	4800 / 4000	V~
M_s	to heatsink	5 ± 15 %	Nm
M_t	to terminals	3 ± 15 %	Nm
a		5 * 9,81	m/s ²
m	approx.	95	g
Case	SKKD	A 10	
	SKKE	A 12	

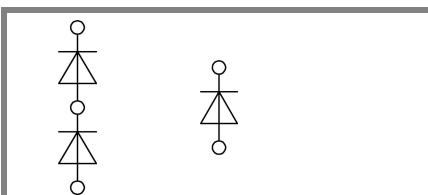

SKKD

SKKE

SKKD 81, SKKE 81

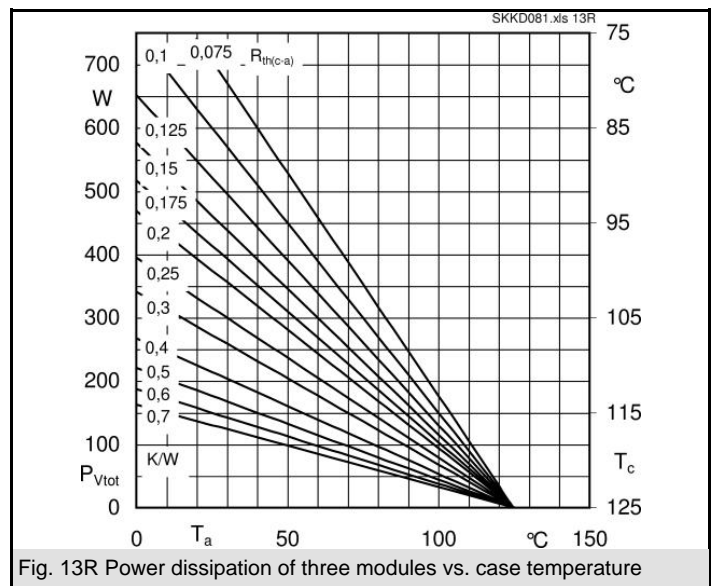
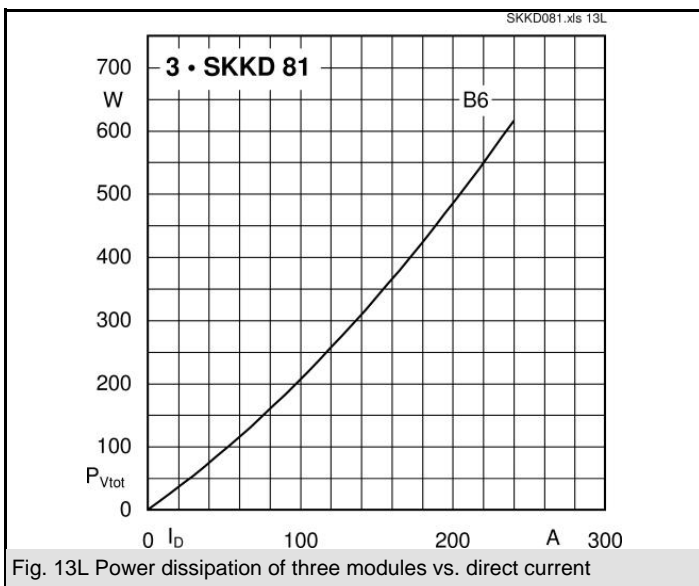
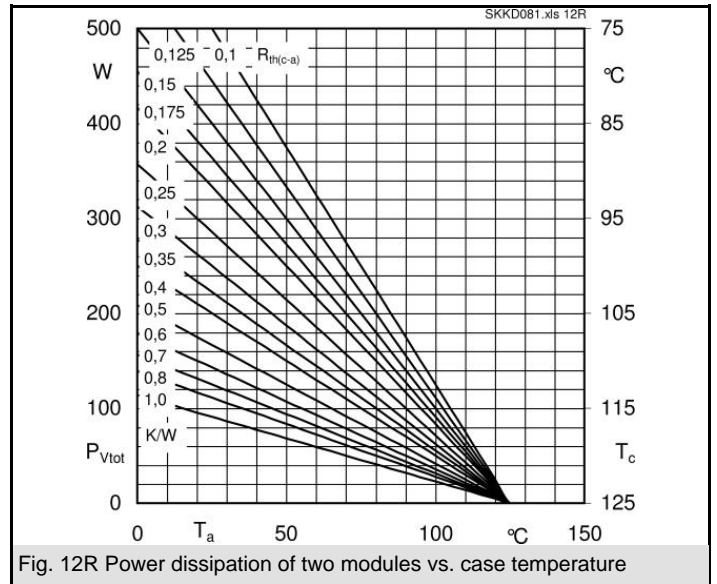
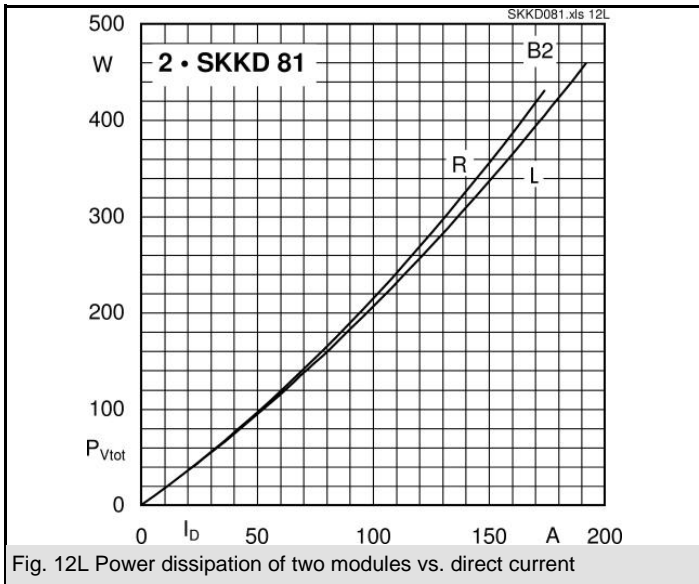
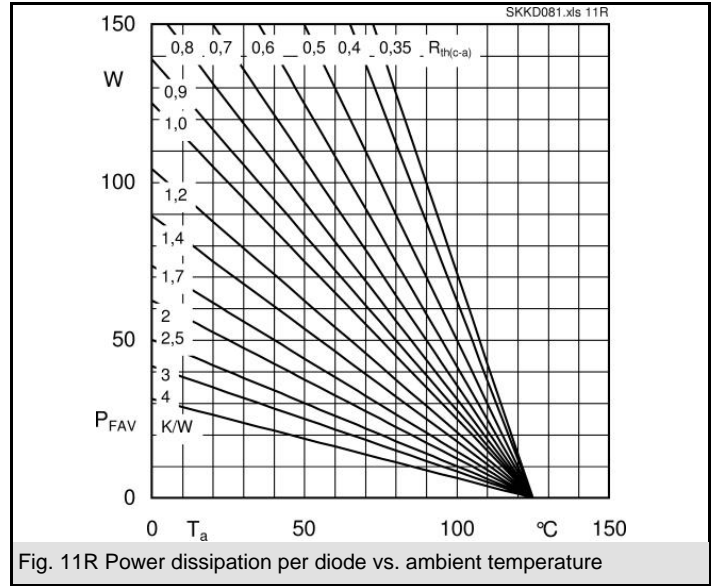
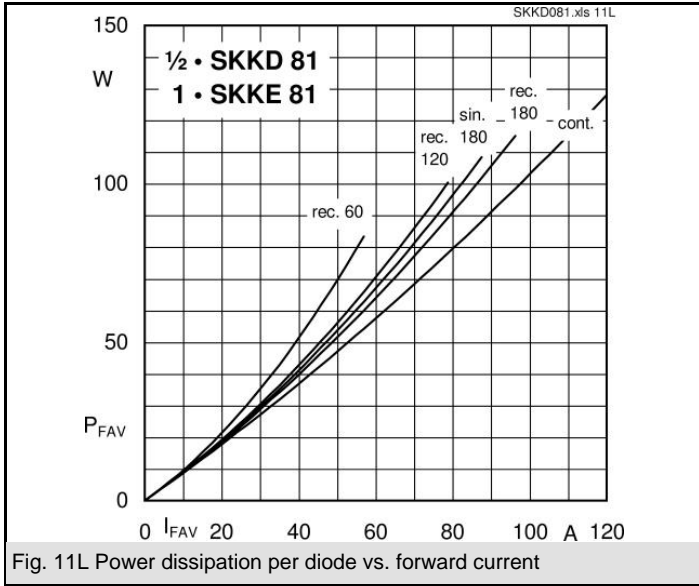

SKKD 81, SKKE 81

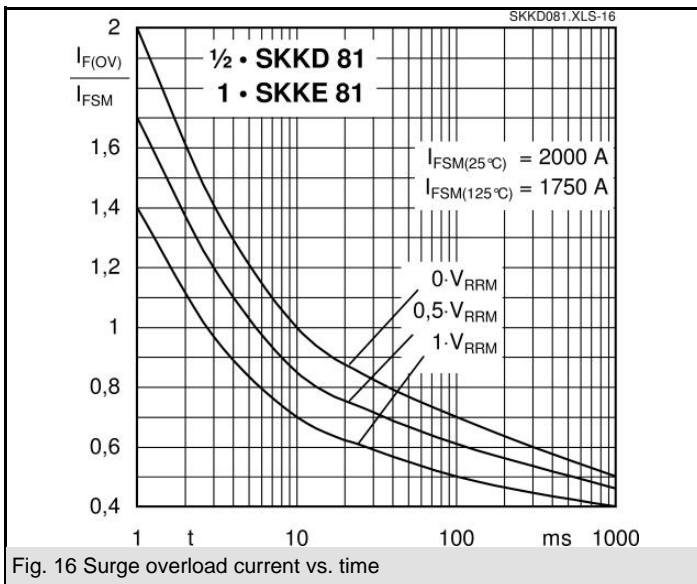
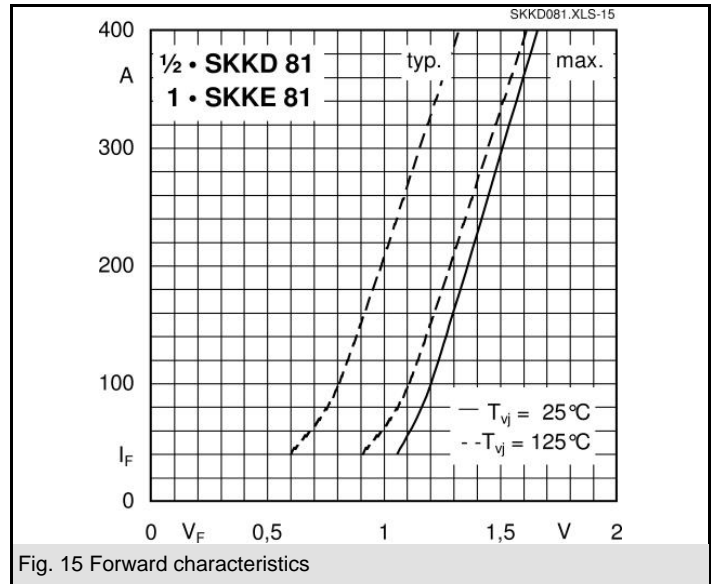
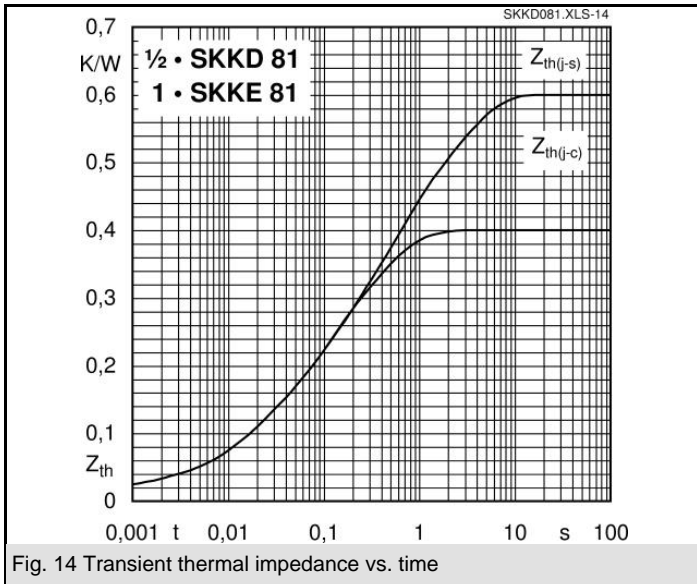

SKKD 81, SKKE 81

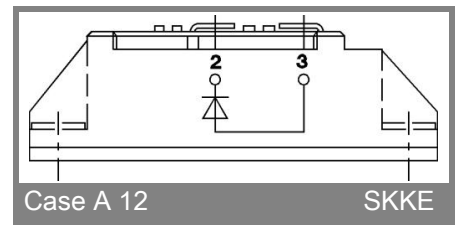
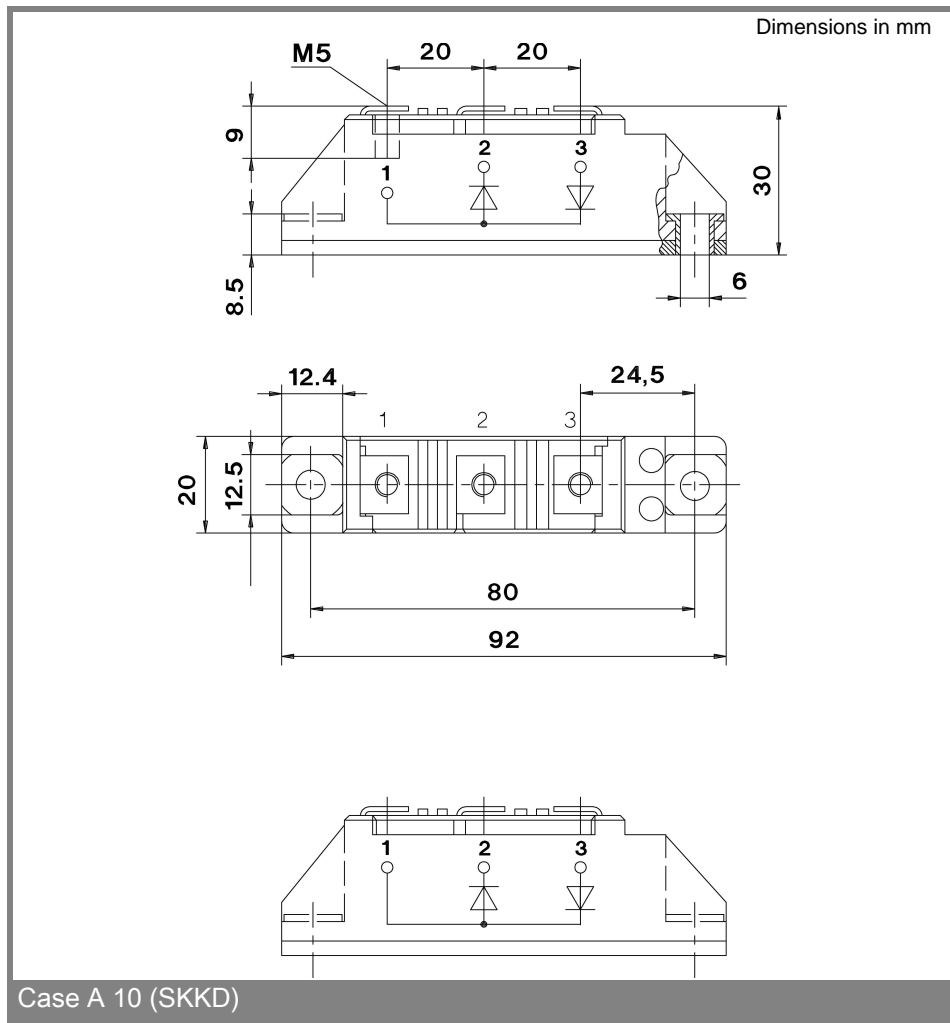

This technical information specifies semiconductor devices but promises no characteristics. No warranty or guarantee expressed or implied is made regarding delivery, performance or suitability.