

IGBT MODULE (U series) 600V / 100A



■ Features

- Low $V_{CE(sat)}$
- Compact Package
- P.C. Board Mount Module

■ Applications

- Inverter for Motoe Drive
- AC and DC Servo Drive Amplifier
- Uninterruptible Power Supply

■ Maximum ratings and characteristics

● Absolute maximum ratings ($T_c=25^{\circ}\text{C}$ unless otherwise specified)

Item	Symbol	Condition	Rating	Unit
Collector-Emitter voltage	V_{CES}		600	V
Gate-Emitter voltage	V_{GES}		± 20	V
Collector current	I_c	Continuous	100	A
	I_{cP}	1ms	200	
	$-I_c$		100	
	$-I_c$ pulse		200	
Collector power dissipation	P_c	1 device	380	W
Operating junction temperature	T_j		+150	$^{\circ}\text{C}$
Storage temperature	T_{stg}		-40 to +125	$^{\circ}\text{C}$
Isolation voltage	V_{iso}	AC : 1 minute	AC 2500	V
			AC 2500	V
Mounting screw torque			3.5 *1	N·m

*1 Recommendable value : 2.5 to 3.5 N·m (M5)

*2 All terminals should be connected together when isolation test will be done.

*3 Two thermistor terminals should be connected together, each other terminals should be connected together and shorted to base plate when isolation test will be done.

● Electrical characteristics (Tj=25°C unless otherwise specified)

Item	Symbol	Condition	Characteristics			Unit		
			Min.	Typ.	Max.			
Inverter	Zero gate voltage collector current	ICES	VCE=600V, VGE=0V			-	mA	
	Gate-Emitter leakage current	IGES	VCE=0V, VGE=±20V			-	nA	
	Gate-Emitter threshold voltage	VGE(th)	VCE=20V, Ic=100mA			6.2	V	
	Collector-Emitter saturation voltage	VCE(sat) (terminal)	VGE=15V Ic=100A	Tj=25°C	-	2.20	2.50	V
				Tj=125°C	-	2.35	-	
		VCE(sat) (chip)		Tj=25°C	-	1.85	-	
				Tj=125°C	-	2.00	-	
	Input capacitance	Cies	VGE=0V, VCE=10V, f=1MHz			-	nF	
	Turn-on time	ton	VCC=300V			-	µs	
		tr	Ic=100A			-		
		tr(i)	VGE=±15V			-		
	Turn-off time	toff	RG= 33 Ω			-	µs	
		tf				-		
	Forward on voltage	VF (terminal)	VGE= 0 V IF=100A	Tj=25°C	-	1.95	2.30	V
				Tj=125°C	-	2.00	-	
VF (chip)		Tj=25°C		-	1.60	-		
		Tj=125°C		-	1.65	-		
Reverse recovery time	trr	IF=100A			-	µs		
Lead resistance, terminal-chip *	R lead				-	mΩ		
Thermistor	Resistance	R	T=25°C	-	5000	-	Ω	
			T=100°C	465	495	520		
	B value	B	T=25/50°C			3305	3375	3450

* Biggest internal terminal resistance among arm.

● Thermal resistance Characteristics

Item	Symbol	Condition	Characteristics			Unit	
			Min.	Typ.	Max.		
Thermal resistance (1 device)	Rth(j-c)	IGBT	-	-	0.33	°C/W	
		FWD	-	-	0.66		
Contact thermal resistance *	Rth(c-f)	With thermal compound			-	0.05	-

* This is the value which is defined mounting on the additional cooling fin with thermal compound

■ Equivalent Circuit Schematic

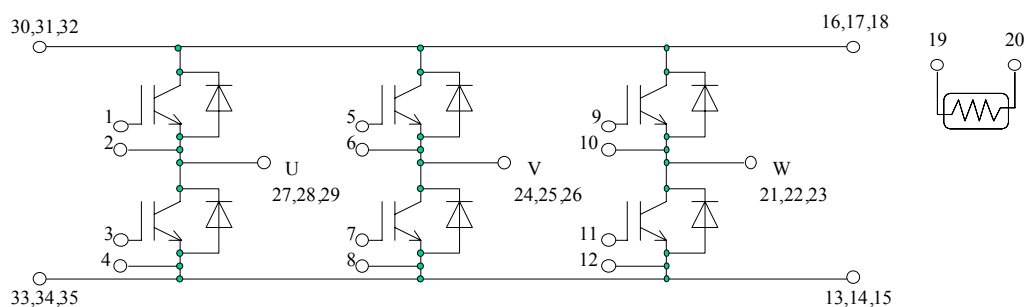

■ Characteristics (Representative)

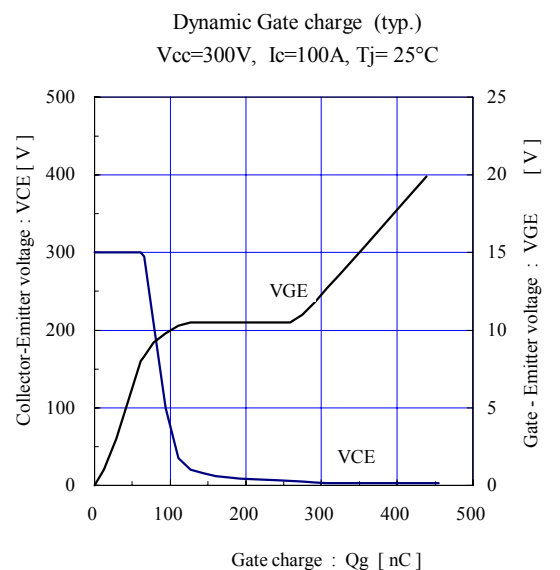
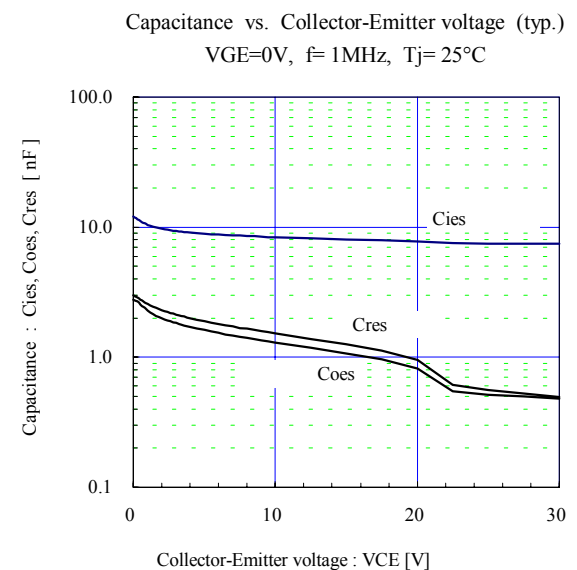
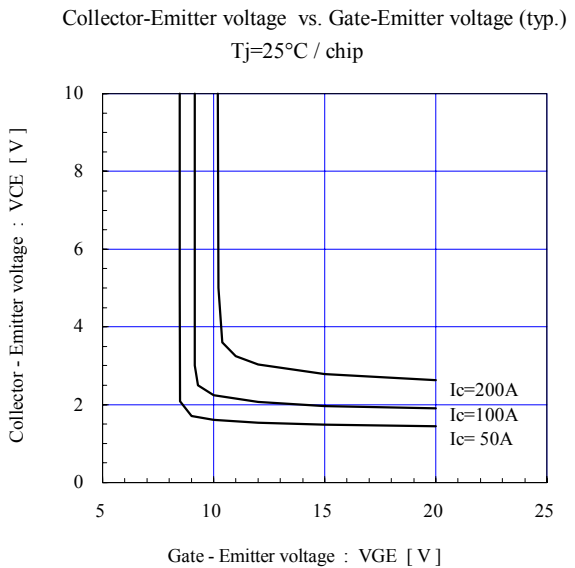
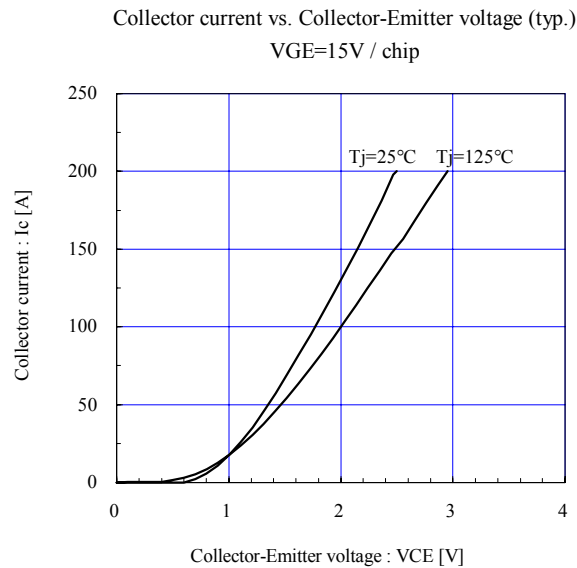
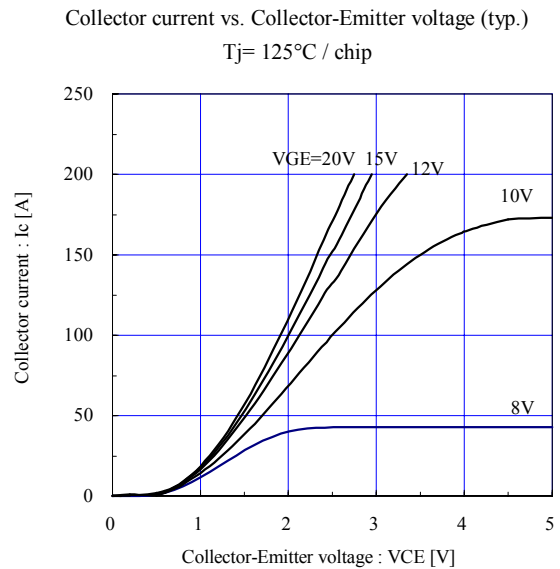
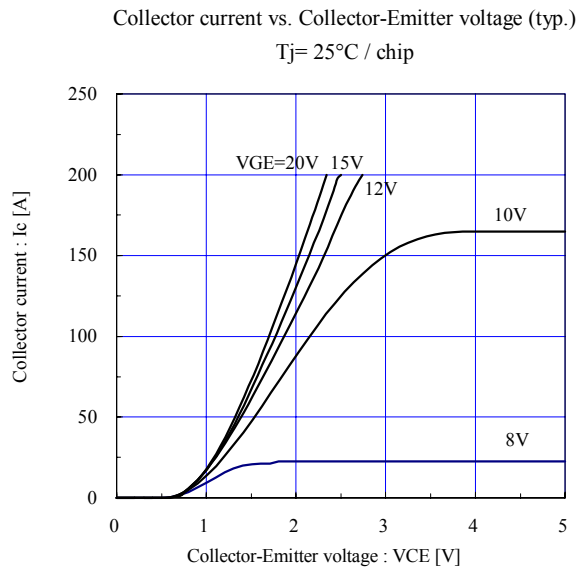

Switching time vs. Collector current (typ.)
 $V_{cc}=300V, V_{GE}=\pm 15V, R_g=33\Omega, T_j=25^\circ C$

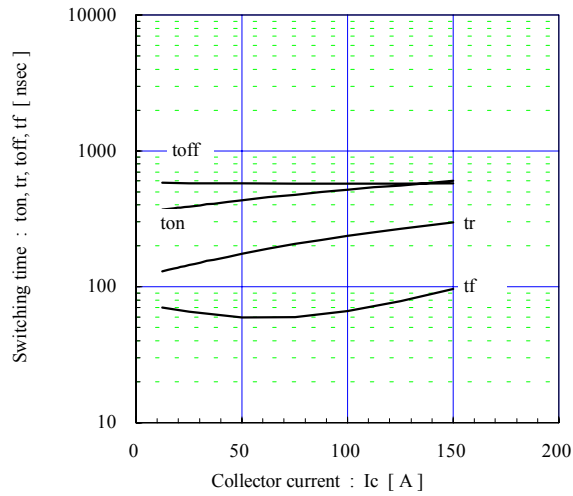

Switching time vs. Collector current (typ.)
 $V_{cc}=300V, V_{GE}=\pm 15V, R_g=33\Omega, T_j=125^\circ C$

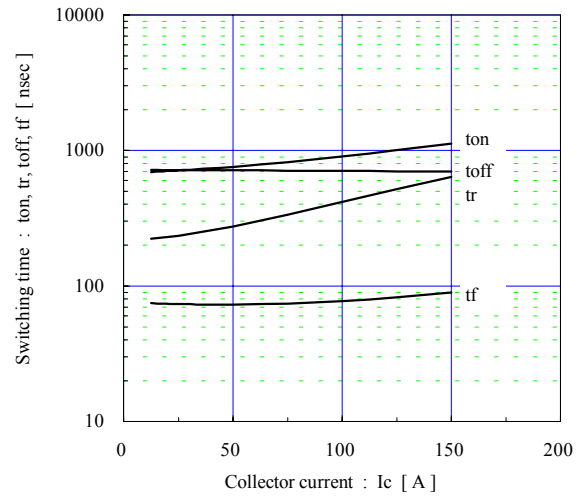

Switching time vs. Gate resistance (typ.)
 $V_{cc}=300V, I_c=100A, V_{GE}=\pm 15V, T_j=25^\circ C$

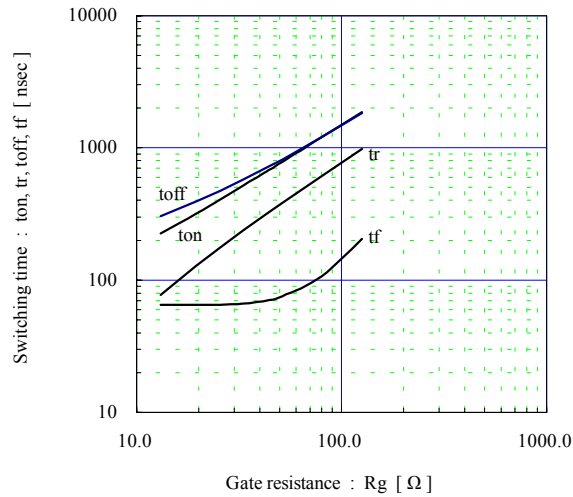

Switching loss vs. Collector current (typ.)
 $V_{cc}=300V, V_{GE}=\pm 15V, R_g=33\Omega$

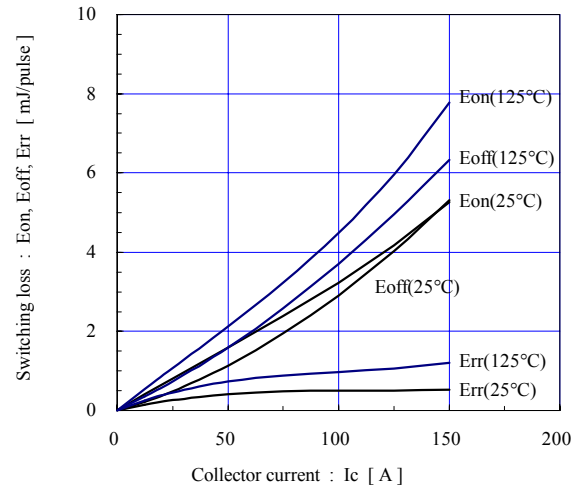

Switching loss vs. Gate resistance (typ.)
 $V_{cc}=300V, I_c=100A, V_{GE}=\pm 15V, T_j=125^\circ C$

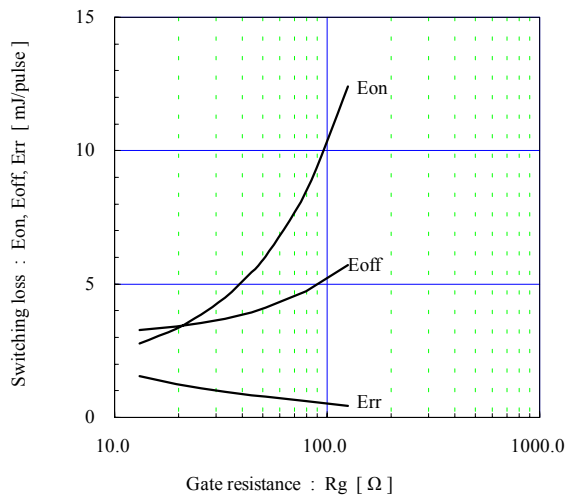

Reverse bias safe operating area (max.)
 $+V_{GE}=15V, -V_{GE} \le 15V, R_g \ge 33\Omega, T_j \le 125^\circ C$

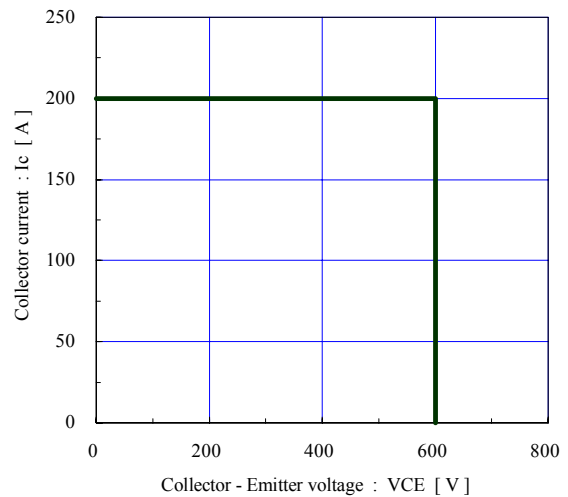

Forward current vs. Forward on voltage (typ.)
chip

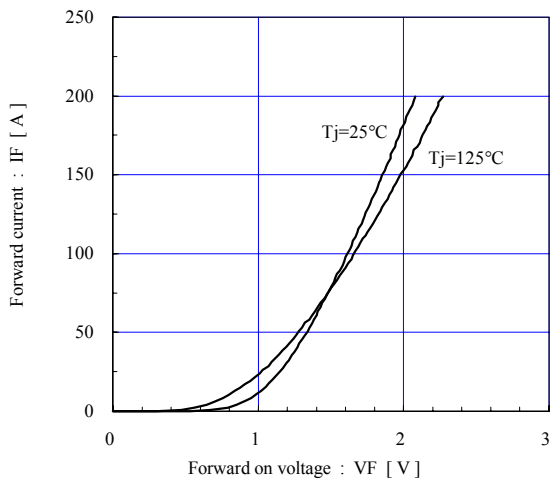

Reverse recovery characteristics (typ.)
Vcc=300V, VGE=±15V, Rg=33Ω

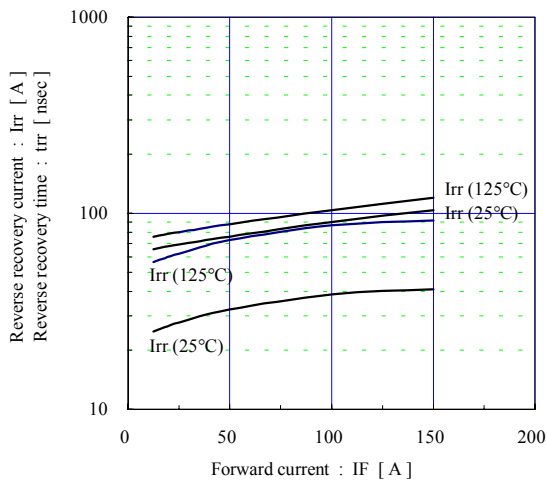

Transient thermal resistance (max.)

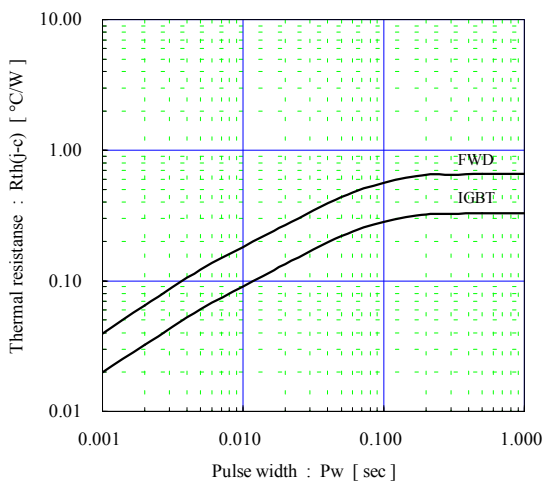

Temperature characteristic (typ.)

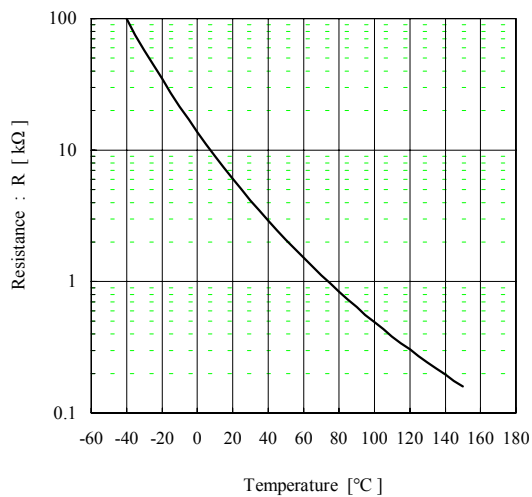

■ Outline Drawings, mm

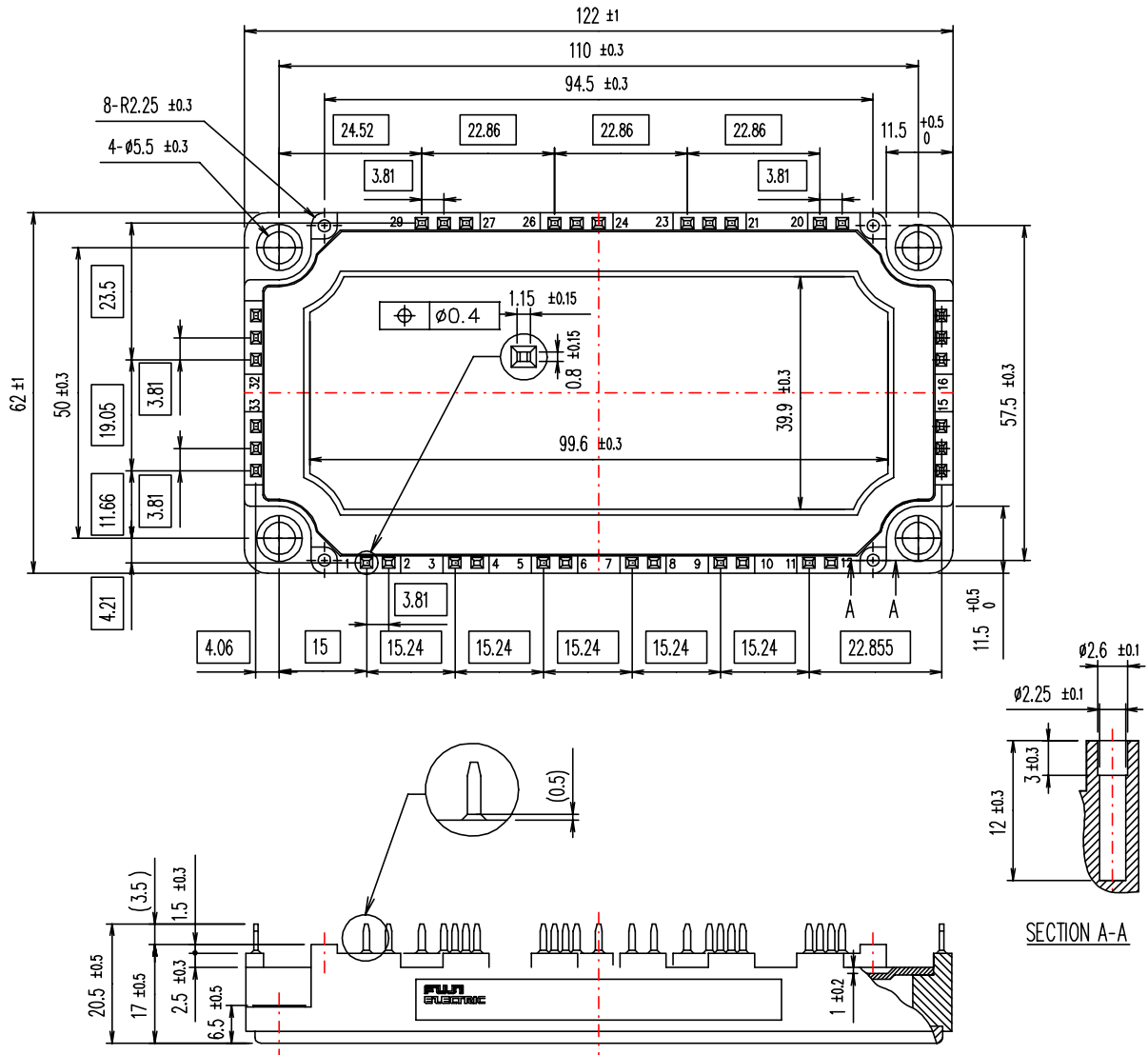

□ shows theoretical dimension.

() shows reference dimension.