

N-CHANNEL SILICON POWER MOSFET

F- II SERIES

Features

- High current
- Low on-resistance
- No secondary breakdown
- Low driving power
- High voltage
- $V_{GS}=\pm 30V$ Guarantee

Applications

- Switching regulators
- UPS
- DC-DC converters
- General purpose power amplifier

Maximum ratings and characteristics

Absolute maximum ratings ($T_c=25^\circ C$ unless otherwise specified)

Item	Symbol	Rating	Unit
Drain-source voltage	V_{DS}	500	V
Continuous drain current	I_D	30	A
Pulsed drain current	$I_{D(puls)}$	92	A
Continuous reverse drain current	I_{DR}	30	A
Gate-source peak voltage	V_{GS}	± 30	V
Max. power dissipation	P_D	300	W
Operating and storage temperature range	T_{ch}	+150	$^\circ C$
	T_{stg}	-55 to +150	$^\circ C$

Electrical characteristics ($T_c = 25^\circ C$ unless otherwise specified)

Item	Symbol	Test Conditions	Min.	Typ.	Max.	Units
Drain-source breakdown voltage	$V_{(BR)DSS}$	$I_D=1mA$ $V_{GS}=0V$	500			V
Gate threshold voltage	$V_{GS(th)}$	$I_D=1mA$ $V_{DS}=V_{GS}$	2.5	3.5	5.0	V
Zero gate voltage drain current	I_{DSS}	$V_{DS}=500V$ $V_{GS}=0V$	$T_{ch}=25^\circ C$	10	500	μA
			$T_{ch}=125^\circ C$	0.2	1.0	mA
Gate-source leakage current	I_{GSS}	$V_{GS}=\pm 30V$ $V_{DS}=0V$		10	100	nA
Drain-source on-state resistance	$R_{DS(on)}$	$I_D=15A$ $V_{GS}=10V$		0.18	0.25	Ω
Forward transconductance	g_{fs}	$I_D=15A$ $V_{DS}=25V$	10.0	20.0		S
Input capacitance	C_{iss}	$V_{DS}=25V$		4200	6300	pF
Output capacitance	C_{oss}	$V_{GS}=0V$		600	900	
Reverse transfer capacitance	C_{rss}	$f=1MHz$		280	420	
Turn-on time t_{on} ($t_{on}=t_{d(on)}+t_r$)	$t_{d(on)}$	$V_{CC}=300V$ $R_G=25\ \Omega$		60	90	ns
	t_r	$I_D=30A$		300	450	
Turn-off time t_{off} ($t_{off}=t_{d(off)}+t_f$)	$t_{d(off)}$	$V_{GS}=10V$		600	900	
	t_f			300	450	
Diode forward on-voltage	V_{SD}	$I_F=2 \times I_{DR}$ $V_{GS}=0V$ $T_{ch}=25^\circ C$		1.10	1.7	V
Reverse recovery time	t_{rr}	$I_F=I_{DR}$ $di/dt=100A/\mu s$ $T_{ch}=25^\circ C$		600		ns

Thermal characteristics

Item	Symbol	Test Conditions	Min.	Typ.	Max.	Units
Thermal resistance	$R_{th(ch-a)}$	channel to ambient				$^\circ C/W$
	$R_{th(ch-c)}$	channel to case			0.416	$^\circ C/W$

Outline Drawings

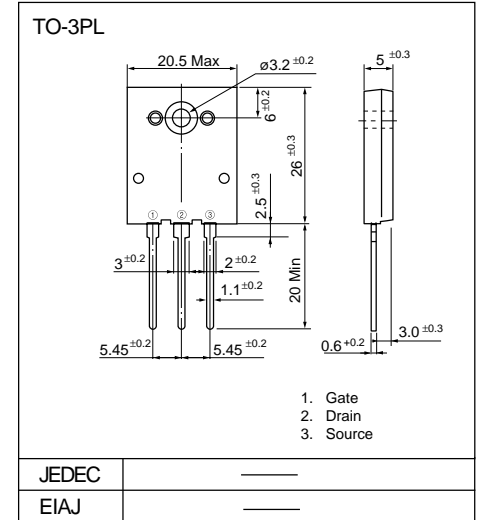

Equivalent circuit schematic

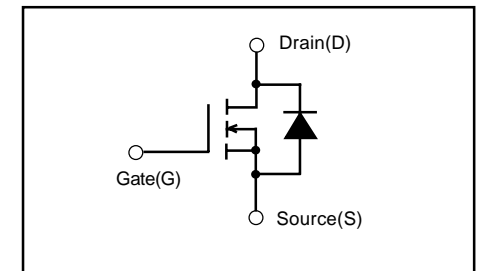

Characteristics

Typical output characteristics

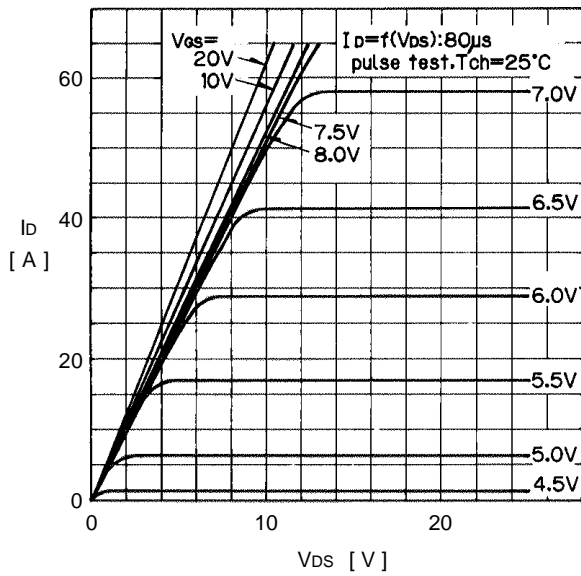

Drain-Source on state resistance vs. T_{ch}

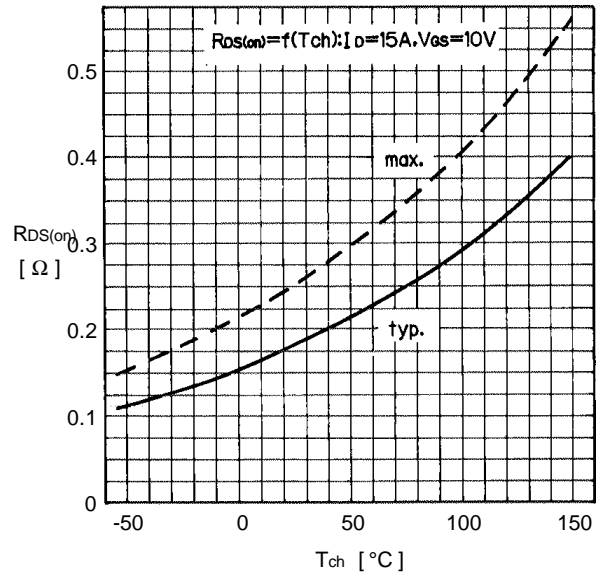

Typical transfer characteristics

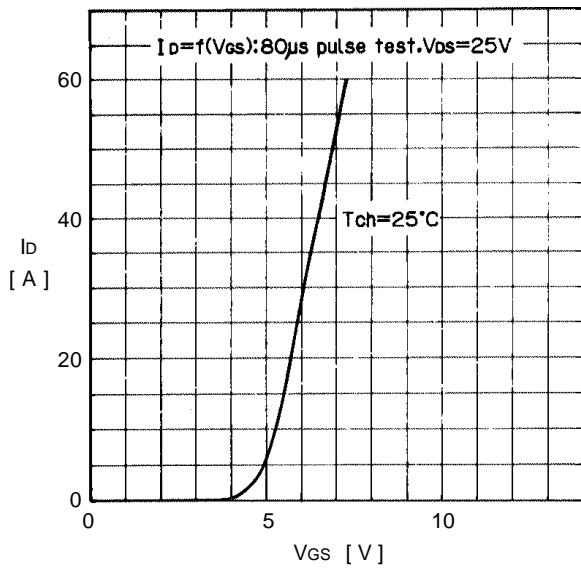

Typical Drain-Source on state resistance vs. I_D

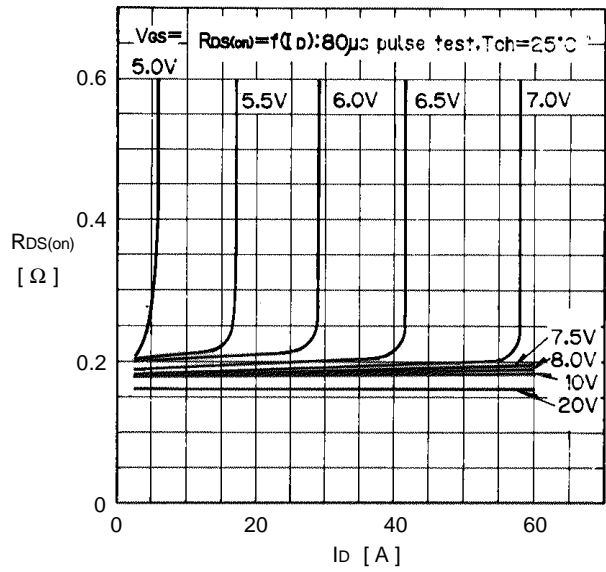

Typical forward transconductance vs. I_D

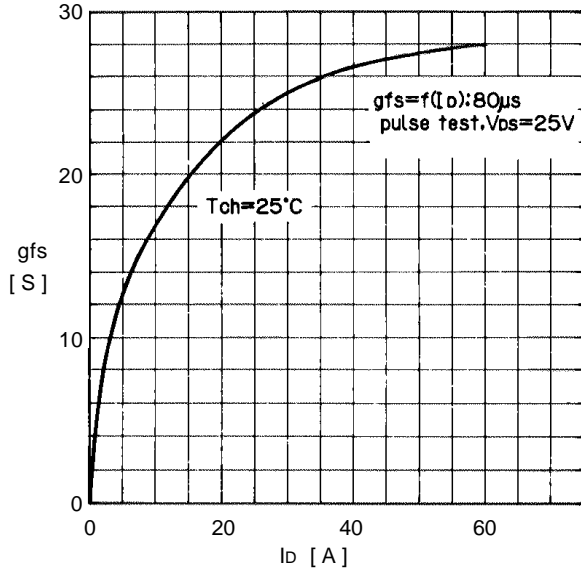

Gate threshold voltage vs. T_{ch}

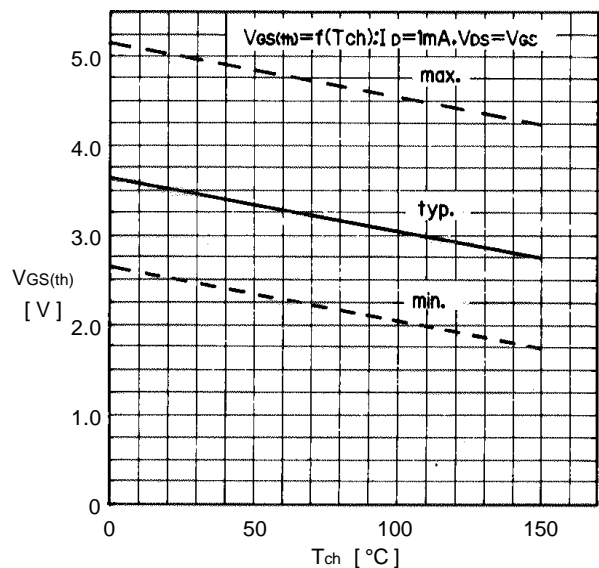

Typical capacitance vs. V_{DS}

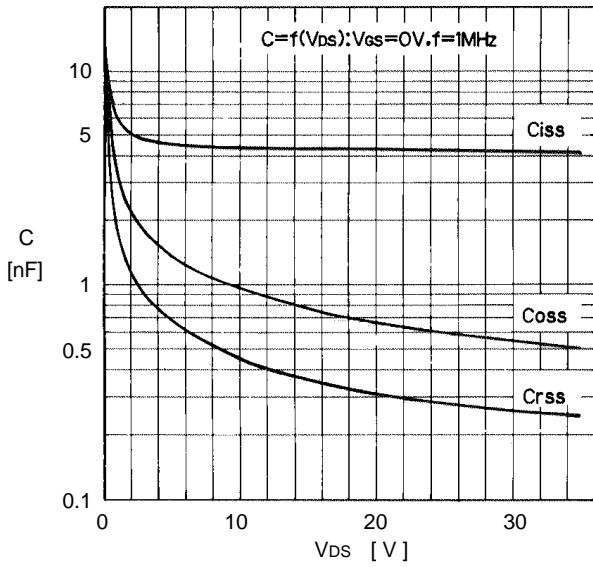

Typical input charge

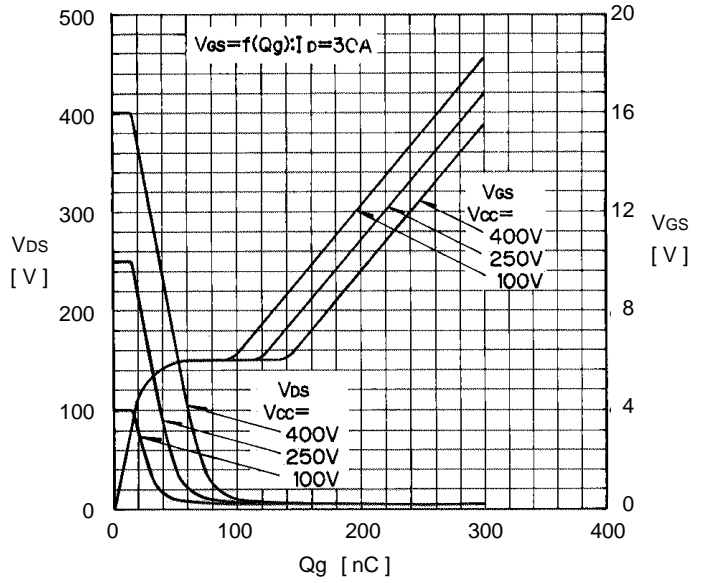

Forward characteristics of reverse diode

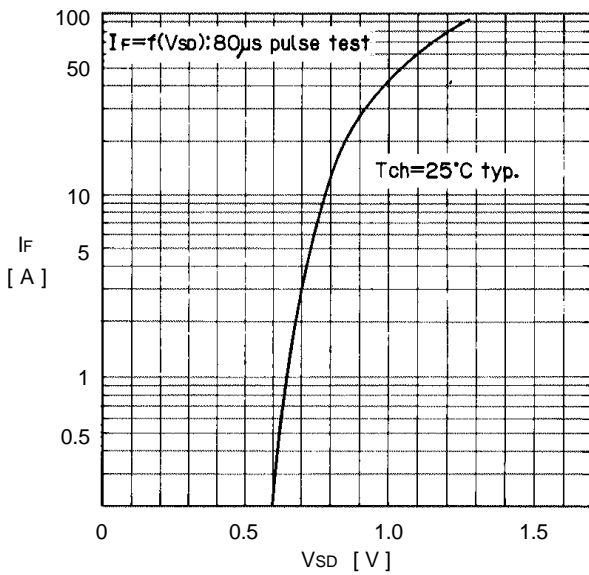

Allowable power dissipation vs. T_c

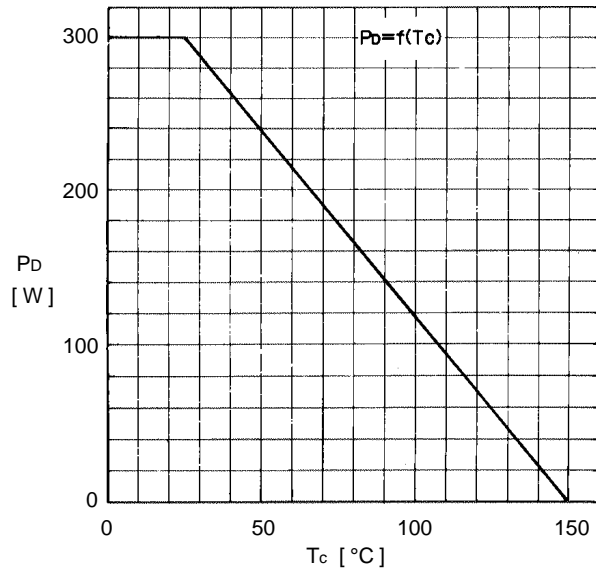

Transient thermal impedance

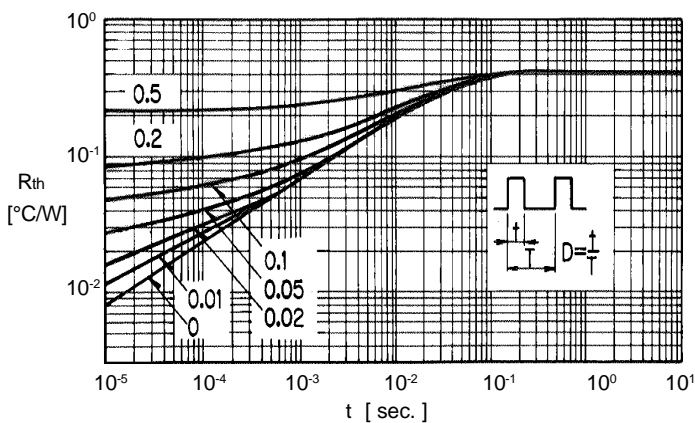

Safe operating area

