



MACMIC

November 2011

PRELIMINARY

MMG100D170B6EN

1700V 100A IGBT Module

RoHS Compliant

FEATURES

- IGBT³ CHIP(1700V Trench+Field Stop technology)
- Low turn-off losses, short tail current
- $V_{CE(sat)}$ with positive temperature coefficient
- DIODE CHIP(1700V EMCON 3 technology)
- Free wheeling diodes with fast and soft reverse recovery



APPLICATIONS

- High frequency switching application
- Medical applications
- Motion/servo control
- UPS systems

ABSOLUTE MAXIMUM RATINGS

T_C=25°C unless otherwise specified

Symbol	Parameter	Test Conditions	Values	Unit
IGBT				
V_{CES}	Collector - Emitter Voltage	$T_{vj}=25^{\circ}C$	1700	V
V_{GES}	Gate - Emitter Voltage		± 20	V
I_c	DC Collector Current	$T_C=25^{\circ}C$	150	A
		$T_C=80^{\circ}C$	100	A
I_{CM}	Repetitive Peak Collector Current	$t_p=1ms$	200	A
P_{tot}	Power Dissipation Per IGBT		690	W
Diode				
V_{RRM}	Repetitive Reverse Voltage	$T_{vj}=25^{\circ}C$	1700	V
$I_{F(AV)}$	Average Forward Current	$T_C=25^{\circ}C$	150	A
		$T_C=80^{\circ}C$	100	A
I_{FRM}	Repetitive Peak Forward Current	$t_p=1ms$	200	A
I^2t		$T_{vj} =125^{\circ}C, t=10ms, V_R=0V$	1650	A ² s

MMG100D170B6EN

ELECTRICAL AND THERMAL CHARACTERISTICS $T_C=25^\circ\text{C}$ unless otherwise specified

Symbol	Parameter	Test Conditions	Min.	Typ.	Max.	Unit
IGBT						
$V_{GE(th)}$	Gate - Emitter Threshold Voltage	$V_{CE}=V_{GE}, I_C=4.0\text{mA}$	5.2	5.8	6.4	V
$V_{CE(sat)}$	Collector - Emitter Saturation Voltage	$I_C=100\text{A}, V_{GE}=15\text{V}, T_{Vj}=25^\circ\text{C}$		2.0	2.45	V
		$I_C=100\text{A}, V_{GE}=15\text{V}, T_{Vj}=125^\circ\text{C}$		2.4		V
I_{CES}	Collector Leakage Current	$V_{CE}=1700\text{V}, V_{GE}=0\text{V}, T_{Vj}=25^\circ\text{C}$			3	mA
		$V_{CE}=1700\text{V}, V_{GE}=0\text{V}, T_{Vj}=125^\circ\text{C}$			20	mA
I_{GES}	Gate Leakage Current	$V_{CE}=0\text{V}, V_{GE} \pm 20\text{V}, T_{Vj}=125^\circ\text{C}$	-400		400	nA
R_{Gint}	Integrated Gate Resistor			4.8		Ω
Q_{ge}	Gate Charge	$V_{CE}=900\text{V}, I_C=100\text{A}, V_{GE}=\pm 15\text{V}$		1.2		μC
C_{ies}	Input Capacitance	$V_{CE}=25\text{V}, V_{GE}=0\text{V}, f=1\text{MHz}$		9		nF
C_{res}	Reverse Transfer Capacitance				0.3	
$t_{d(on)}$	Turn - on Delay Time	$V_{CC}=900\text{V}, I_C=100\text{A}, T_{Vj}=25^\circ\text{C}$		370		ns
		$R_G=4\ \Omega, T_{Vj}=125^\circ\text{C}$		400		ns
t_r	Rise Time	$V_{GE}=\pm 15\text{V}, T_{Vj}=25^\circ\text{C}$		40		ns
		Inductive Load $T_{Vj}=125^\circ\text{C}$		50		ns
$t_{d(off)}$	Turn - off Delay Time	$V_{CC}=900\text{V}, I_C=100\text{A}, T_{Vj}=25^\circ\text{C}$		650		ns
		$R_G=4\ \Omega, T_{Vj}=125^\circ\text{C}$		800		ns
t_f	Fall Time	$V_{GE}=\pm 15\text{V}, T_{Vj}=25^\circ\text{C}$		180		ns
		Inductive Load $T_{Vj}=125^\circ\text{C}$		300		ns
E_{on}	Turn - on Energy	$V_{CC}=900\text{V}, I_C=100\text{A}, T_{Vj}=25^\circ\text{C}$		22		mJ
		$R_G=4\ \Omega, T_{Vj}=125^\circ\text{C}$		32		mJ
E_{off}	Turn - off Energy	$V_{GE}=\pm 15\text{V}, T_{Vj}=25^\circ\text{C}$		21		mJ
		Inductive Load $T_{Vj}=125^\circ\text{C}$		31		mJ
I_{sc}	Short Circuit Current	$t_{psc} \leq 10\ \mu\text{s}, V_{GE}=15\text{V}$ $T_{Vj}=125^\circ\text{C}, V_{CC}=1000\text{V}$		400		A
R_{thJC}	Junction-to-Case Thermal Resistance (Per IGBT)				0.18	K/W
Diode						
V_F	Forward Voltage	$I_F=100\text{A}, V_{GE}=0\text{V}, T_{Vj}=25^\circ\text{C}$		1.8	2.2	V
		$I_F=100\text{A}, V_{GE}=0\text{V}, T_{Vj}=125^\circ\text{C}$		1.9		V
I_{RRM}	Max. Reverse Recovery Current	$I_F=100\text{A}, V_R=900\text{V}$		160		A
Q_{rr}	Reverse Recovery Charge	$di_F/dt=-2400\text{A}/\mu\text{s}$		48		μC
E_{rec}	Reverse Recovery Energy	$T_{Vj}=125^\circ\text{C}$		27		mJ
R_{thJCD}	Junction-to-Case Thermal Resistance (Per Diode)				0.26	K/W

MODULE CHARACTERISTICS

T_C=25°C unless otherwise specified

Symbol	Parameter	Test Conditions	Min.	Typ.	Max.	Unit
T _{Vj max}	Max. Junction Temperature				150	°C
T _{Vj op}	Operating Temperature		-40		125	°C
T _{stg}	Storage Temperature		-40		125	°C
V _{isol}	Insulation Test Voltage	AC, t=1min		4000		V
CTI	Comparative Tracking Index		350			
Torque	Module-to-Sink	Recommended (M6)	3		5	N · m
Torque	Module Electrodes	Recommended (M6)	2.5		5	N · m
Weight				320		g

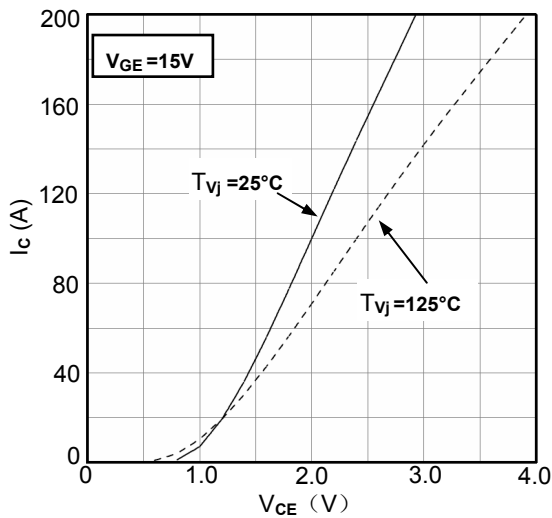

Figure1. Typical Output Characteristics

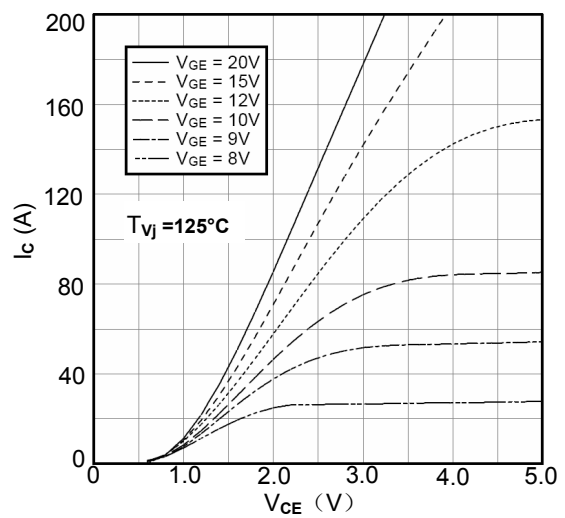

Figure2. Typical Output Characteristics

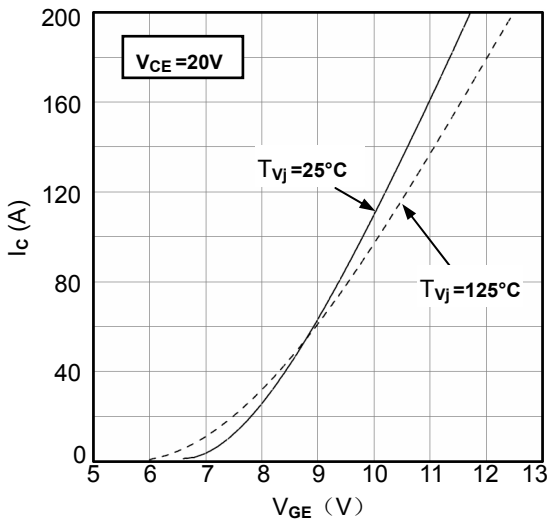

Figure3. Typical Transfer characteristics

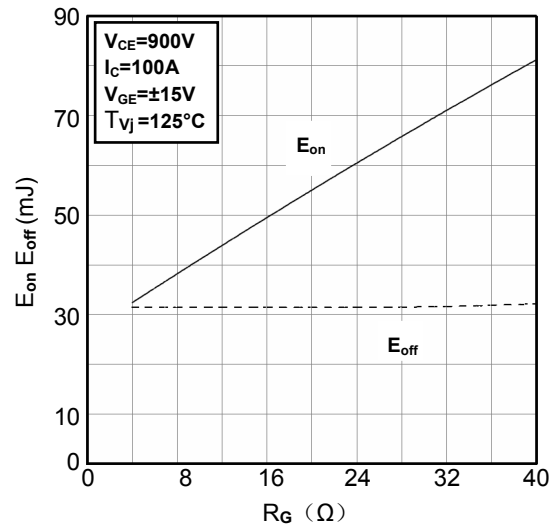

Figure4. Switching Energy vs. Gate Resistor

MMG100D170B6EN

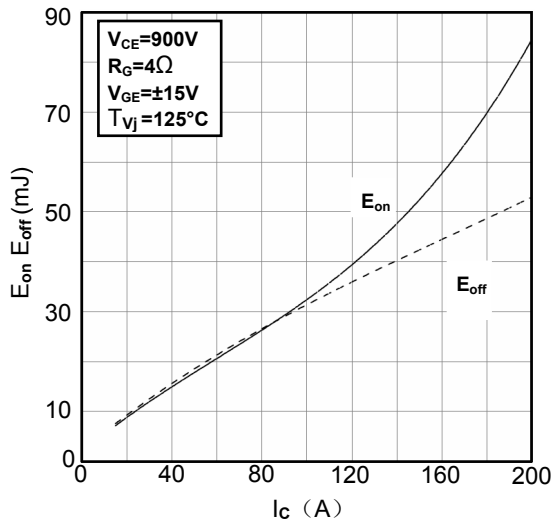

Figure 5. Switching Energy vs. Collector Current

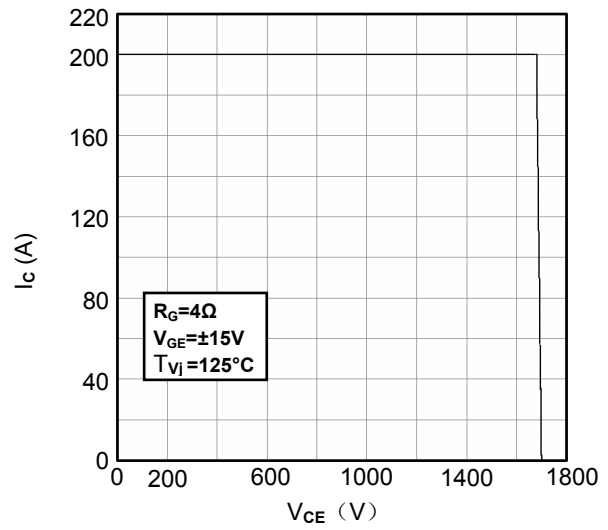

Figure 6. Reverse Biased Safe Operating Area

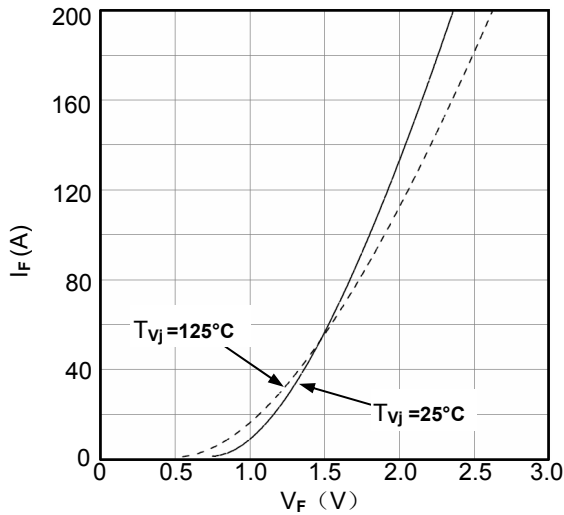

Figure 7. Diode Forward Characteristics

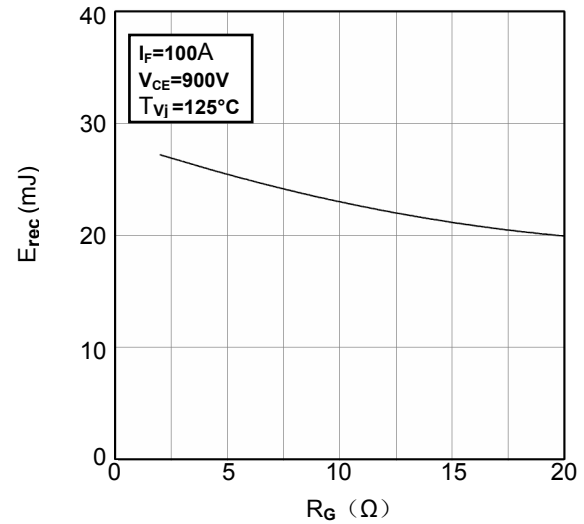

Figure 8. Switching Energy vs. Gate Resistor

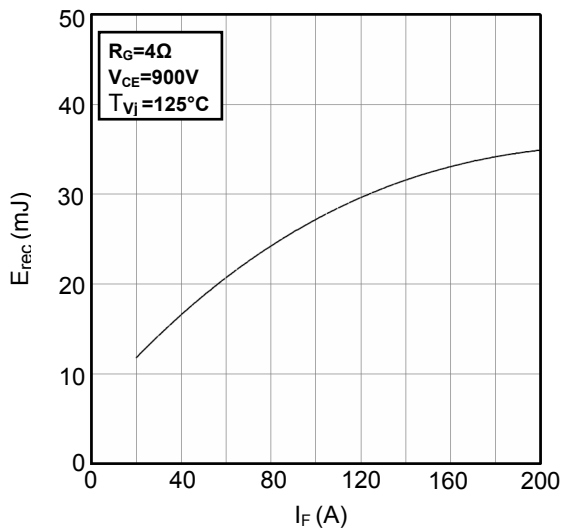

Figure 9. Switching Energy vs. Forward Current

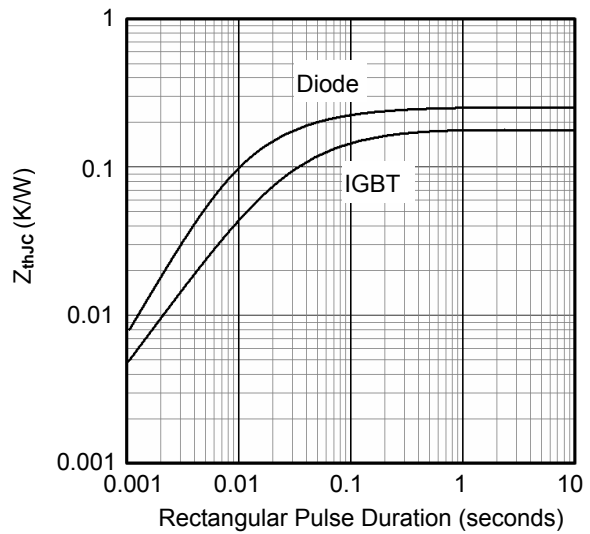

Figure 10. Transient Thermal Impedance of Diode and IGBT

MMG100D170B6EN

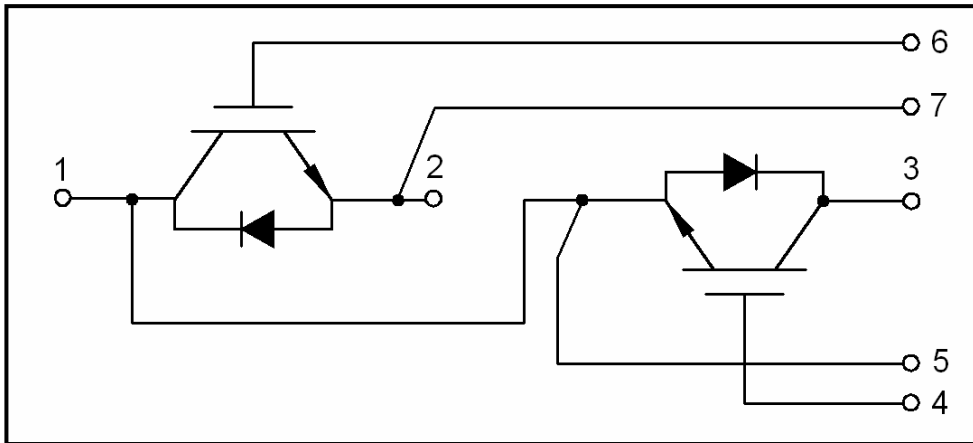
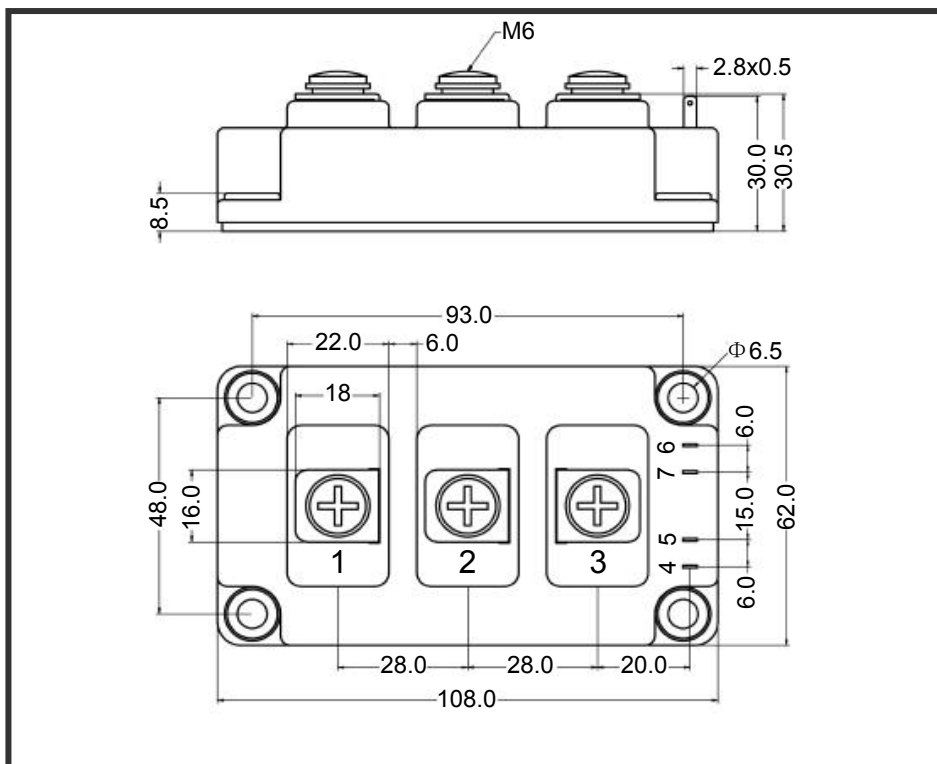

Figure11. Circuit Diagram



Dimensions (mm)
Figure12. Package Outline